



EN

**Radio-Controlled Projection Clock  
with Indoor / Outdoor Temperature  
Model: RMR329P  
USER MANUAL**

**Precautions ..... 6**  
**Specifications ..... 7**  
**About Oregon Scientific ..... 7**  
**EU-Declaration of conformity ..... 7**

**CONTENTS**

**Introduction..... 2**  
**Clock overview ..... 2**  
 Front view..... 2  
 Back view ..... 2  
 Remote sensor ..... 3  
**Getting started ..... 3**  
 Power supply..... 3  
**Remote sensor..... 3**  
 Sensor data transmission..... 4  
**Clock..... 4**  
 Clock reception ..... 4  
 Manually set clock ..... 4  
**Alarm ..... 5**  
**Temperature ..... 5**  
**Projector and backlight..... 5**  
**Reset..... 6**

## INTRODUCTION

Thank you for selecting this Oregon Scientific™ Radio-Controlled Projection Clock with Indoor / Outdoor Temperature. Please keep this manual for instructions and information you should know about.

## CLOCK OVERVIEW

### FRONT VIEW



1. **SNOOZE:** Snooze alarm; activate backlight; rotate dual line projection display by 180°
2. **ALARM:** View alarm status; set alarm
3. **CLOCK:** Change display; set clock

4. ▼ / ▲: Toggle setting options; activate / deactivate clock reception
5. Projector (LED Aperture)
6. **TEMP:** Toggle in / out temperature settings

### BACK VIEW

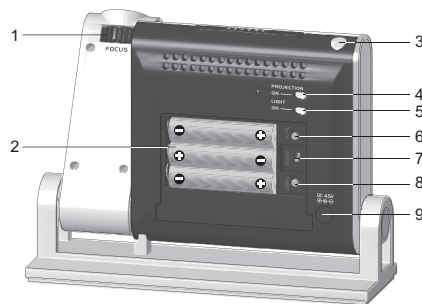

1. **FOCUS:** Focus the projected image
2. Battery compartment
3. Light sensor
4. **PROJECTION:** ON / OFF switch
5. **LIGHT:** Backlight ON / OFF switch
6. **°C / °F:** Select temperature unit
7. **EU / UK:** Radio signal switch
8. **RESET:** Reset settings to default
9. Adapter socket



## REMOTE SENSOR

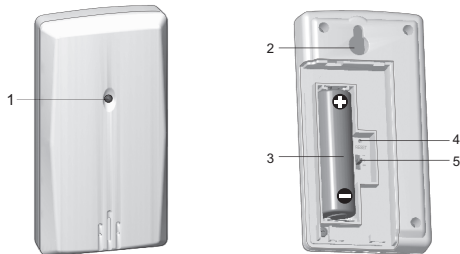

1. LED status indicator
2. Wall mount hole
3. Battery compartment
4. **RESET** hole: Reset unit to default settings
5. **CHANNEL** button: Select channel 1

## GETTING STARTED

### POWER SUPPLY

Batteries serve as a back-up power supply. For continuous use of projector and backlight, install adapter. The socket-outlet shall be installed near the equipment and shall be easily accessible.

**NOTE**  will appear when power supply is not connected.

### To insert batteries:

1. Remove the battery compartment and insert batteries, matching polarities.
2. Press **RESET** after each battery change.

 LOCATION	MEANING
Clock / alarm area	Main unit batteries low
Outdoor / indoor temperature area	Sensor batteries low

## REMOTE SENSOR

### To set up the sensor:

1. Open the battery compartment, and insert batteries, matching polarities.
2. Place the sensor within 30 m (98 ft) of the main unit using the table stand or wall mount.

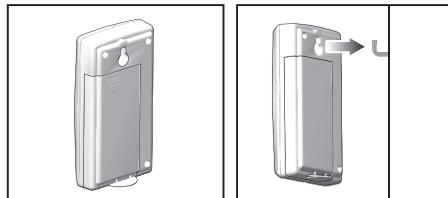



The transmission range may vary depending on many factors. You may need to experiment with various locations to get the best results.

**NOTE** We recommend that you use alkaline batteries with this product for longer usage and consumer grade lithium batteries in temperatures below freezing.

## SENSOR DATA TRANSMISSION

### Outdoor sensor:

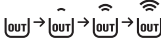
The main unit will automatically search for the outdoor sensor. The sensor reception icon in the remote sensor area shows the status:

ICON	DESCRIPTION
	Main unit is searching for sensor(s)
	A channel has been found
	The sensor cannot be found.

**NOTE** If the sensor is not found, check the batteries, obstructions, and remote unit location.

### For best results:

- Place the sensor out of direct sunlight and moisture.
- Position the sensor facing main unit, minimizing obstructions.
- Place the sensor in a location with a clear view to the sky, away from metallic or electronic objects.
- Position the sensor close to the main unit during cold winter months.

## CLOCK

### CLOCK RECEPTION

This product is designed to synchronize its clock automatically with a clock signal.

Slide **EU / UK** to select the signal received.



- EU: DCF-77 signal: within 1500 km (932 miles) of Frankfurt, Germany.
- UK: MSF-60 signal: within 1500 km (932 miles) of Anthorn, England.

### To enable / disable signal reception:

Press and hold ▲ to enable, or ▼ to disable signal reception.

**NOTE** Reception takes 2-10 minutes. If the signal is weak, it can take up to 24 hours to get a valid signal.

### Clock signal reception indicator:

STRONG SIGNAL	WEAK SIGNAL	NO SIGNAL
		

### MANUALLY SET CLOCK

1. Press and hold **CLOCK** for 2 seconds.
2. Press ▲ or ▼ to change the settings.
3. Press **CLOCK** to confirm.



- The setting order is: time zone offset, 12/24-hr format, hour, minute, year, day / month format, month, day and language.

**NOTE** Time zone offset sets the clock +/- 23 hours from the received clock signal time.

**NOTE** The language options are (E) English, (F) French, (D) German, (I) Italian, and (S) Spanish.

#### To select display mode:

Press **CLOCK** to choose between clock with seconds and clock with weekday.

## ALARM

#### To set the alarm:

- Press and hold **ALARM** for 2 seconds to enter alarm-setting mode.
- Press **▲** / **▼** to set hour / minute.
- Press **ALARM** to confirm.  indicates alarm is ON.

#### To toggle alarms ON / OFF:

- Press **ALARM** to display alarm time.
- Press **ALARM** again to turn alarm ON / OFF.

#### To silence the alarms:



- Press **SNOOZE** to silence it for 8 minutes
- OR
- Press any other key to turn the alarm off and activate it again after 24 hours.

## TEMPERATURE

#### To toggle temperature unit:

Press **°C** / **°F**.

#### To toggle between outdoor / indoor sensor readings:

Press **TEMP**.  /  indicates indoor and outdoor temperature.

#### To auto-scan between sensors:

Press and hold **TEMP** for 2 seconds to display the sensor's data for 5 seconds.

To deactivate auto-scan function press **TEMP**.

## PROJECTOR AND BACKLIGHT

#### To activate Projection function:

- Slide **PROJECTION** switch to **ON** to illuminate projection continuously.

#### To activate Backlight function:

- Slide **LIGHT** switch to **ON** to illuminate backlight continuously.

OR

- Press **SNOOZE** to turn on projector and backlight for 5 seconds.
- Press repeatedly to flip dual line projection image by 180 degrees.

**NOTE** If projection is illuminated, do not look directly into the projector.



**NOTE** To save battery life, the projector and backlight will only operate continuously when adapter is installed. The light sensor will turn off the projector automatically when it detects external light sources.

## RESET

Press **RESET** to return to the default settings.

## PRECAUTIONS

- Do not subject the unit to excessive force, shock, dust, temperature or humidity.
- Do not cover the ventilation holes with any items such as newspapers, curtains etc.
- Do not immerse the unit in water. If you spill liquid over it, dry it immediately with a soft, lint-free cloth.
- Do not clean the unit with abrasive or corrosive materials.

- Do not tamper with the unit's internal components. This invalidates the warranty.
- Only use fresh batteries. Do not mix new and old batteries.
- Images shown in this manual may differ from the actual display.
- When disposing of this product, ensure it is collected separately for special treatment.
- Placement of this product on certain types of wood may result in damage to its finish for which Oregon Scientific will not be responsible. Consult the furniture manufacture's care instructions for information.
- The contents of this manual may not be reproduced without the permission of the manufacturer.
- Do not dispose old batteries as unsorted municipal waste. Collection of such waste separately for special treatment is necessary.
- Please note that some units are equipped with a battery safety strip. Remove the strip from the battery compartment before first use.

**NOTE** The technical specifications for this product and the contents of the user manual are subject to change without notice.

**SPECIFICATIONS**

TYPE	DESCRIPTION
<b>MAIN UNIT</b>	
L x W x H	155 x 50 x 112 mm (6.1 x 1.97 x 4.41 in)
Weight	240 g (8.5 oz) without battery
Temperature Unit	°C / °F
Temperature range	-5°C to 50°C (23°F to 122°F)
Resolution	0.1°C (0.2°F)
Signal frequency	433 MHz
Power	3 x UM-4 (AAA) 1.5V batteries / 4.5V AC / DC adapter
<b>REMOTE UNIT (THN132N)</b>	
L x W x H	92 x 60 x 20 mm (3.6 x 2.4 x 0.8 in)
Weight	62 g (2.22 ounces)
Transmission range	30 m (98 ft) unobstructed
Temperature range	-30°C to 60°C (-22°F to 140°F)
Power	1 x UM-3 (AA) 1.5V battery

**ABOUT OREGON SCIENTIFIC**

Visit our website ([www.oregonscientific.com](http://www.oregonscientific.com)) to learn more about Oregon Scientific products. If you're in the US and would like to contact our Customer Care department directly, please visit:

[www2.oregonscientific.com/service/support](http://www2.oregonscientific.com/service/support)

OR

Call 1-800-853-8883.

For international inquiries, please visit:



[www2.oregonscientific.com/about/international](http://www2.oregonscientific.com/about/international).

**EU-DECLARATION OF CONFORMITY**

Hereby, Oregon Scientific, declares that this Radio-Controlled Projection Clock with Indoor / Outdoor Temperature (Model: RMR329P) is in compliance with the essential requirements and other relevant provisions of Directive 1999/5/EC. A copy of the signed and dated Declaration of Conformity is available on request via our Oregon Scientific Customer Service.



**COUNTRIES RTE APPROVAL COMPLIED**

All EU countries, Switzerland   
and Norway 



**Radio-Controlled Projection Clock**  
with Indoor / Outdoor Temperature  
**Model: RMR329P**

**USER MANUAL**







© 2007 Oregon Scientific. All rights reserved.

086L004765-023

